

SATRON VVF_e Pressure Transmitter

SATRON VVF_e pressure transmitter belongs to V-transmitter family.

SATRON VVF_e is used for 0 - 4 kPa...0-500 kPa ranges. It is a 2-wire transmitter with HART® standard communication.

SATRON VVF_e pressure transmitter is suitable for liquid level measurements in ground, rock and ships' tanks, drill well and in open channels.

SATRON VVF_e pressure transmitter can be used to measure contaminating liquids. Possible foam on the surface of the measured liquid does not disturb the measurement.

SATRON VVF_e does not require compressed air supply.

The transmitter's sensor is piezoresistive.



Housing: AISI303/316; Seals: Nitrile and Viton®; Nameplates: Polyester

Enclosure class: IP66.

Calibration

For customer-specified range with 1 s. damping. (If range is not specified, transmitter is calibrated for maximum range.)

Electrical connections

Housing with PLUG connector, code **H**:

PLUG connector, connector type DIN 43650 model AF; Pg9 gland for cable; wire cross section 0.5 to 1.5 mm².

Housing with junction box/terminal strip, codes **M** and **N**:

M20x1.5, 1/2-NPT inlet; screw terminals for 0.5 to 2.5 mm² wires.

TECHNICAL SPECIFICATIONS

Measuring range and span

See Selection Chart.

Zero and Span adjustment

Zero elevation: Calibrated span is freely selectable on the specified range depending from the desired option. This can be made by using extern control shafts (analog option), keyboard (display option) or HART®275/375 communicator.

Damping

Time constant is continuously adjustable 0.01 to 60 s.

Response time

Maximum 100 ms

Temperature limits

Process: -10 to +80 °C

Ambient: -30 to +80 °C

Shipping and storage: -40 to +80 °C.

Operating temperature of display:

0 to +50°C (does not affect operation of the transmitter).

Pressure limits

Min. and max. process pressure: See the appended tables.

Volumetric displacement

< 0.5 mm³/max. span

Output 2-wire (2W), 4-20 mA, user selectable for linear, square root, inverted signal or the transfer function (16 points) specified by the user

Supply voltage and permissible load

See the load capacity diagram;
4-20 mA output: 10-35 VDC.

Humidity limits 0-100 % RH; freezing of condensed water is not allowed in reference pressure channels.

PERFORMANCE SPECIFICATIONS

Tested in accordance with IEC 60770: Reference conditions, specified span, no range elevation, AISI316L diaphragm, silicone oil fill.

Accuracy

- ±0.1 % of calibrated span (span 1:1-7.5:1 /max.range).
On the measuring ranges 7.5:1- 50:1:
$$\pm [0.025 + 0.010 \times (\frac{\text{max. span}}{\text{calibrated span}})] \% \text{ of calibrated span}$$

(incl. nonlinearity, hysteresis and repeatability)

Long-term stability

±0.1 % of max. span per 12 months

Temperature effect on compensated temperature ranges -20...+80 °C

Zero and span shift, type VVF_e5:
±0.15 % of max. span

Zero and span shift, type VVF_e4:
±0,25 % of max. span

Mounting position effect

Zero error <0.15 kPa, which can be calibrated out.

Vibration effect (IEC 68-2-6: FC):

±0.1 % of measuring range/
2 g/10 to 2000 Hz
4 g/10 to 100 Hz

Power supply effect

<±0.01 % of calibrated span per volt.

European Directive Information

European Pressure Equipment Directive (PED) (97/23/EY)

- Sound Engineering Practice

Electro Magnetic Compatibility (EMC directive 2004/108/EC)

Insulation test voltage

500 V rms 50 Hz.

CONSTRUCTION AND CALIBRATION

Wetted materials

Metal parts: AISI316L (EN 1.4404)

Jacket of cable: PUR

Other materials: AISI303/316

Fill fluid Silicone oil or inert oil.

Housing with PLUG connector, code H

Housing: AISI316/303

Seals: Viton® and NBR

TEST jacks: MS358Sn/PVDF,

protected with silicone rubber shield.

PLUG connector: PA6-GF30 jacket,

Silicone rubber seal, AISI316 retaining screw.

Housing with junction box/terminal strip, codes M and N:

Pressure limits

Maximum process pressure, MPa

Transmitter type	Max. overload pressure	Pressure class	Minimum process pressure		
			T _{proc.} °C	Minimum process pressure for different fill fluids (kPa,abs.)	
				DC200 100 cSt	Inert oil
VVF _e 4	0.3	PN40	20	5	8
VVF _e 5	1.5	PN40	40	8	10
			80	16	28
			120	21	53

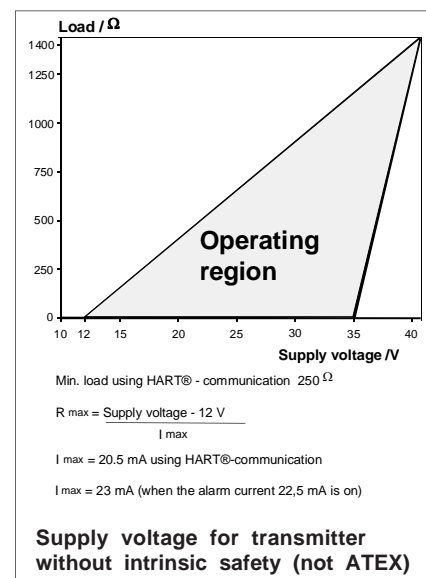

Weight

Transmitter

- with housing type **H** : 0,9 kg
- with housing type **M** : 1,4 kg
- with housing type **N** : 1,5 kg

Product Certifications

European Directive Information

Electro Magnetic Compatibility (EMC directive 2004/108/EC)

All pressure transmitters

Atex Directive (94/9/EC)

Satron Instruments Inc. complies with the ATEX Directive.

European Pressure Equipment Directive (PED) (97/23/EC)

All Pressure Transmitters :
- Sound Engineering Practice

Hazardous Locations Certifications

European Certifications

ATEX Intrinsic Safety

Certification No. : DNV-2007-OSL-ATEX- 1346X

 II 1 GD T135°C EEx ia II C T4 -20°C ≤ Tamb ≤ 50°C

 II 2 GD T135°C EEx ia II C T4 -20°C ≤ Tamb ≤ 50°C

Input Parameters :

$U_i = 28 \text{ V}$

$I_i = 93 \text{ mA}$

$P_i = 0.651 \text{ W}$

$C_i = 5 \text{ nF}$

$L_i = 0.2 \text{ mH}$

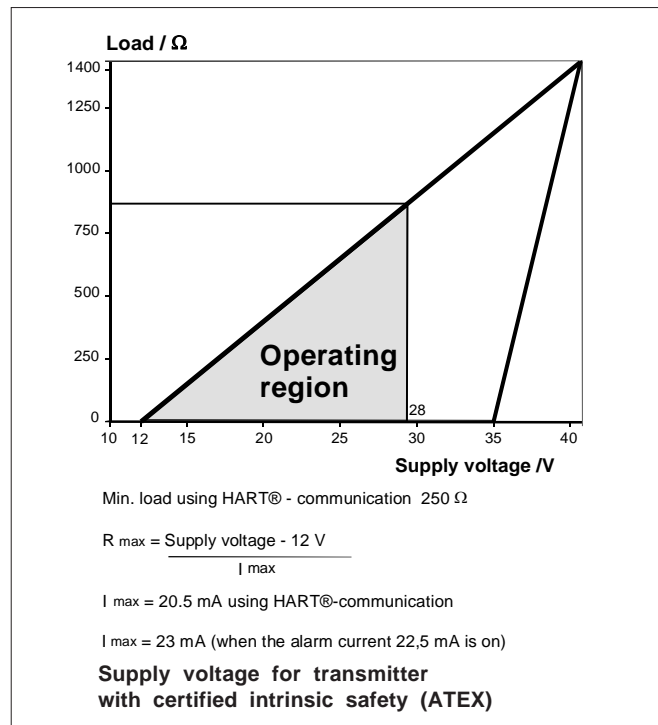

Special Conditions for Safe Use (X) :

The enclosure with plastic window and the plastic DIN43650 connector must not be installed in potentially explosive atmosphere requiring category 1 apparatus.

The non-conducting surface of the sensor element may be charged by the flow of non-conducting media, so there may be electrostatic hazard with IIC-gases. These units should be marked 2 GD.

The equipment shall be installed and connected according to the manufacturers instructions.

Dimensions (mm)

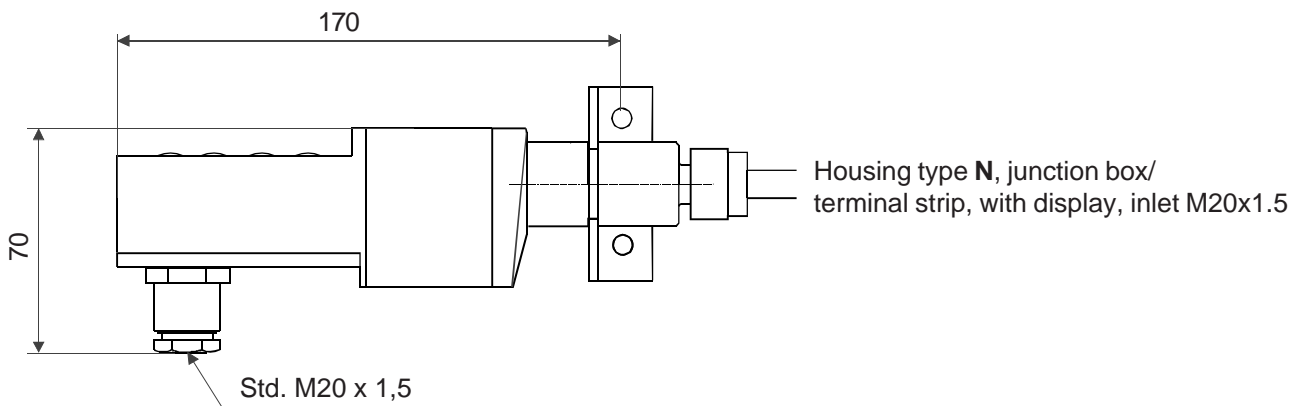
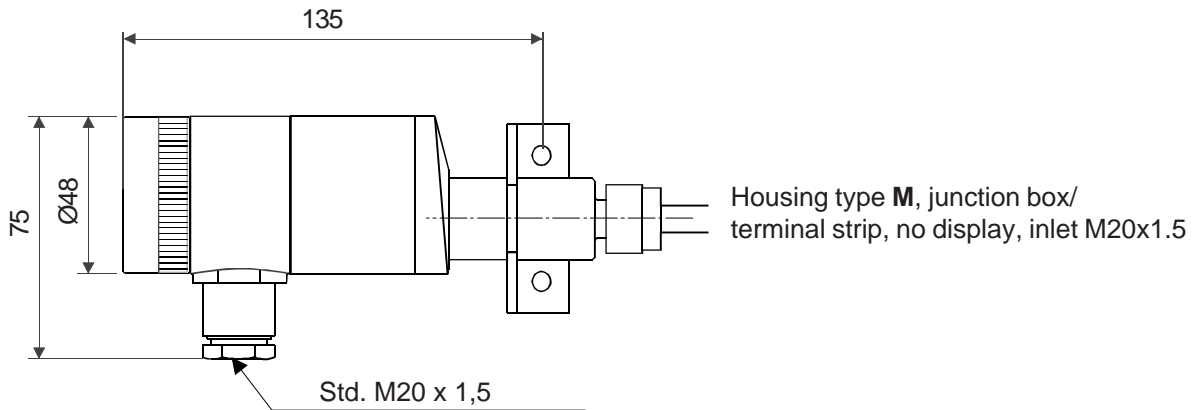
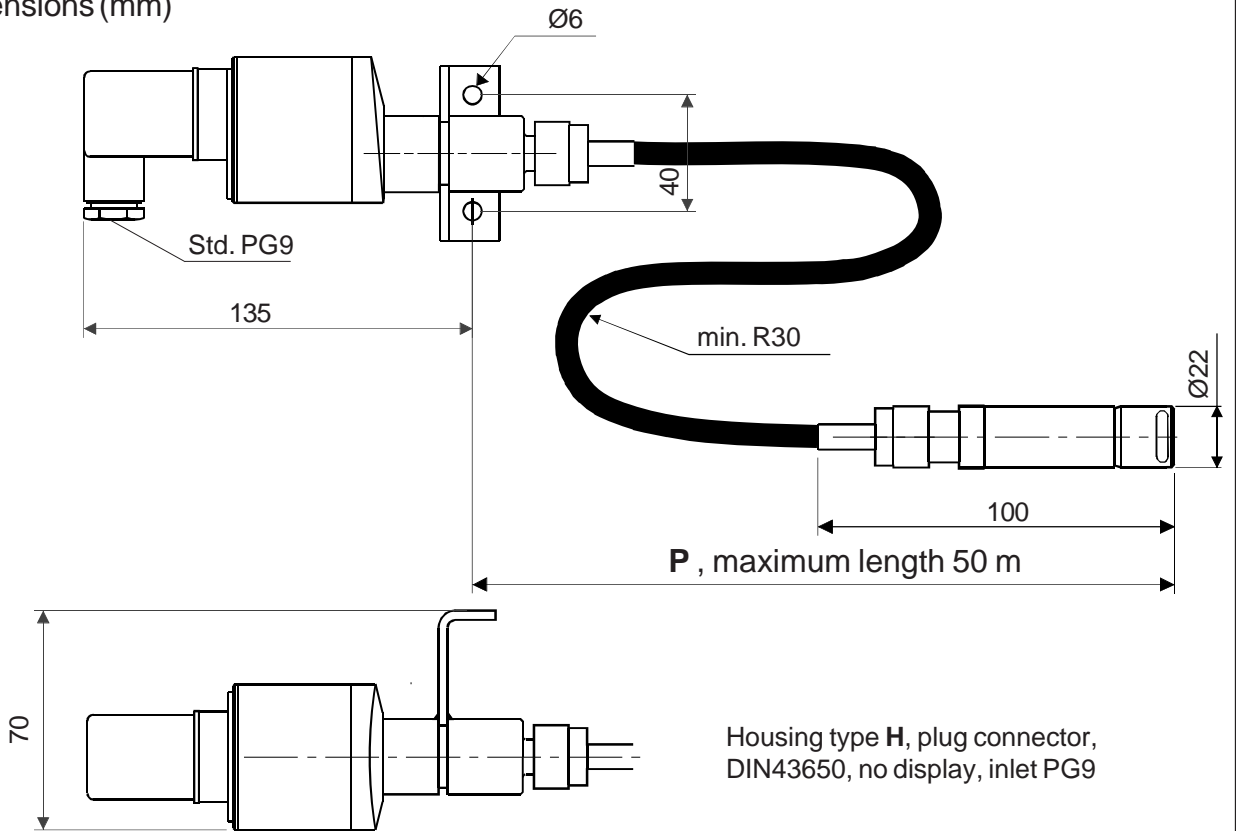

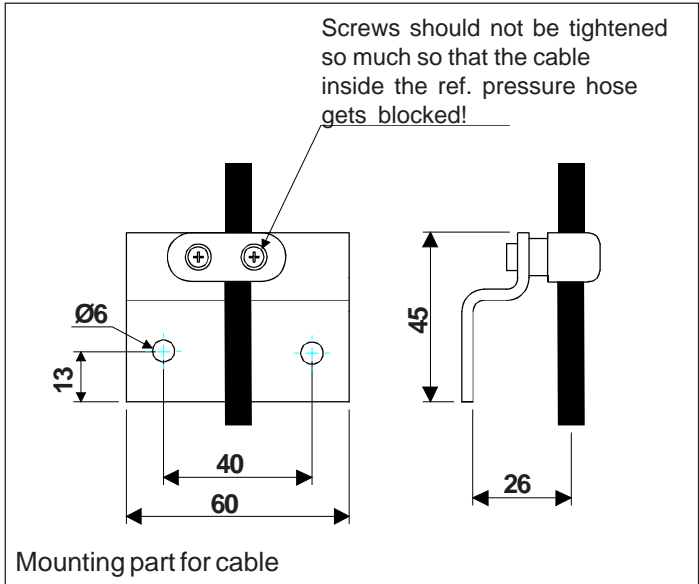
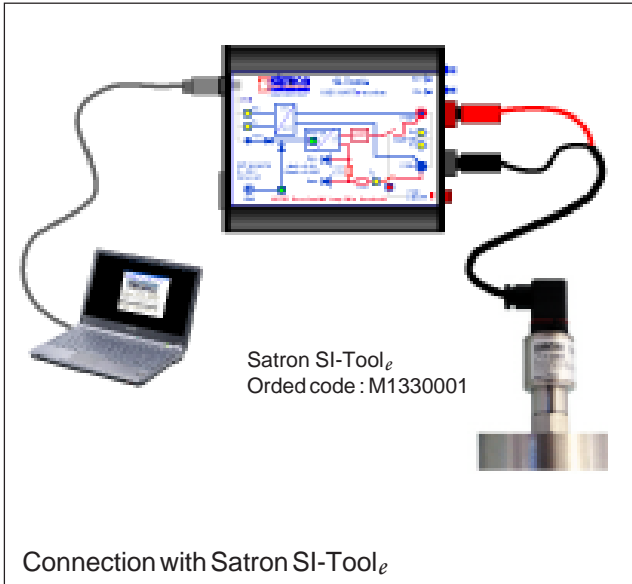
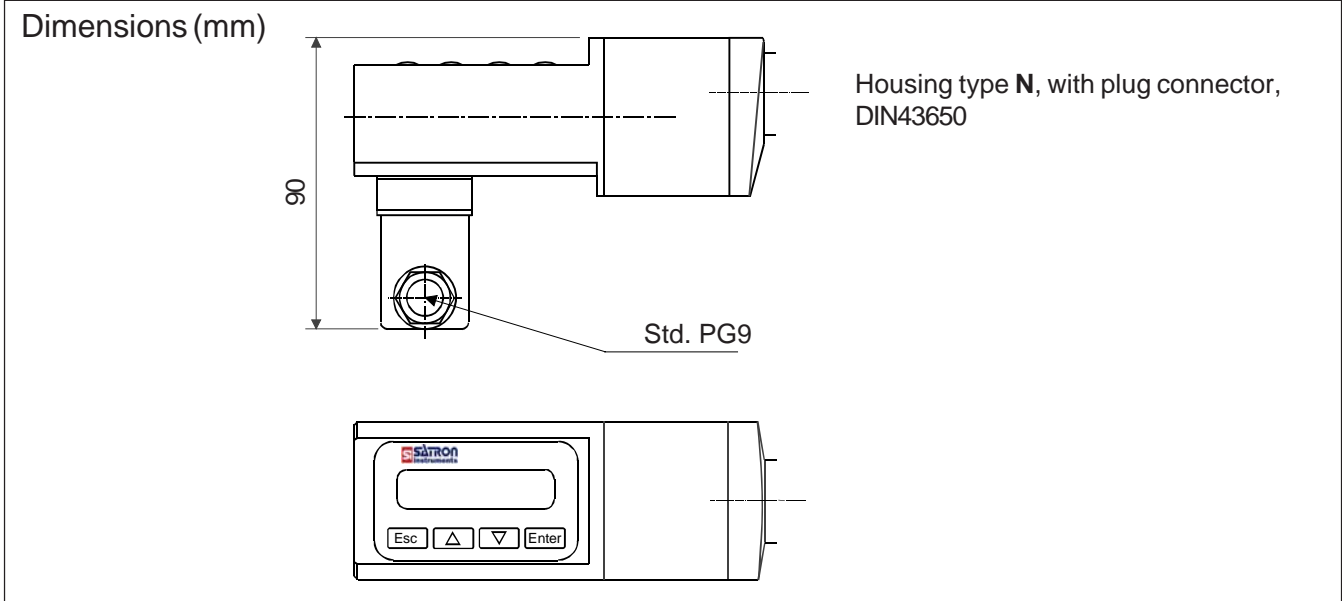

Installation methods

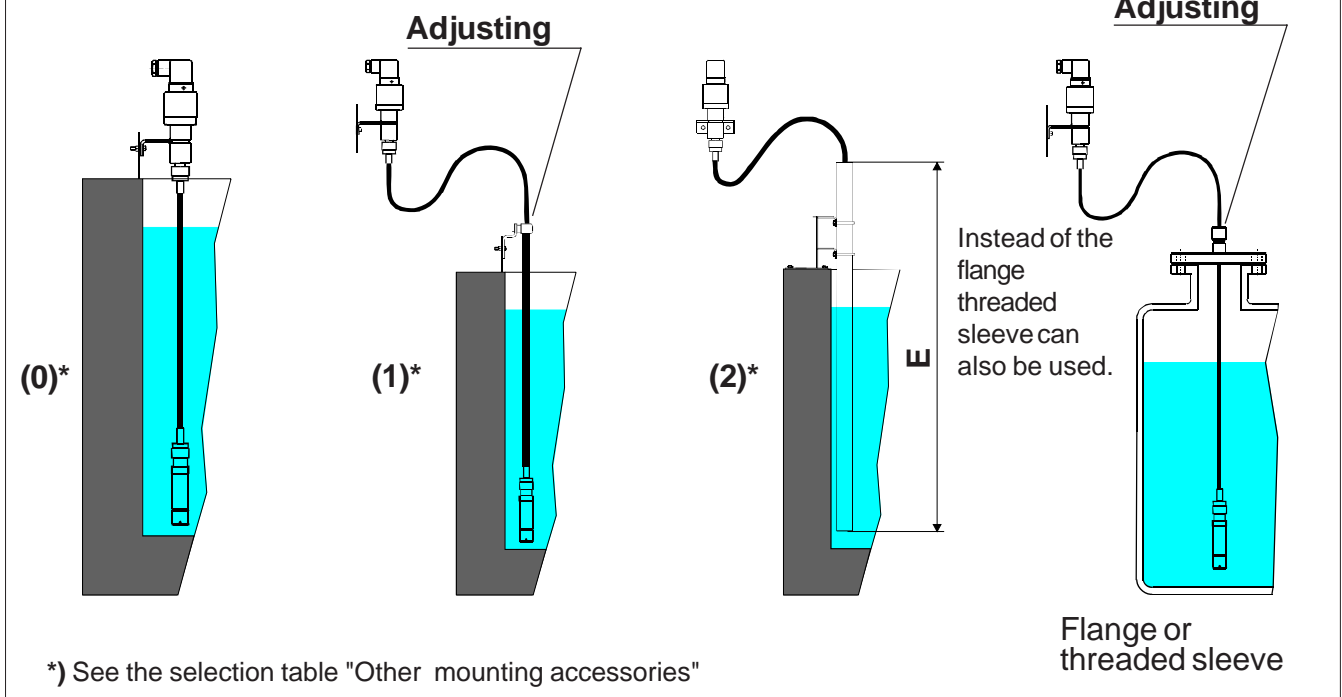

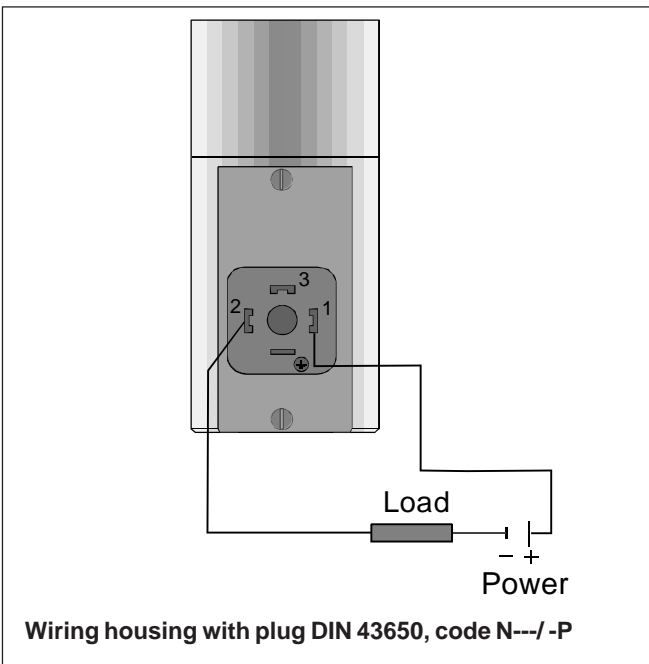
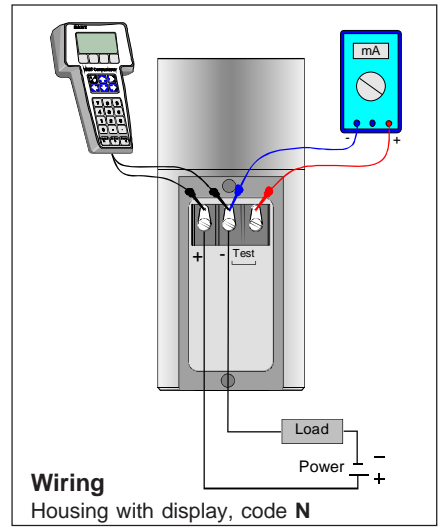
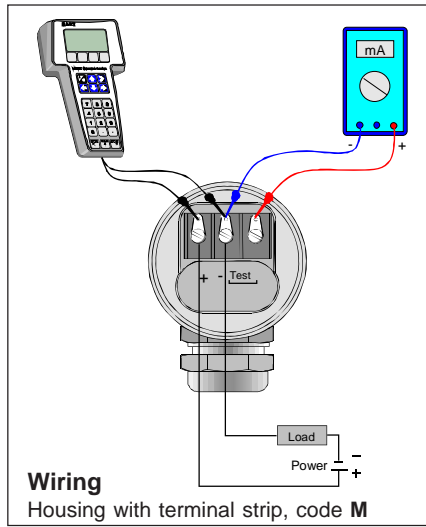
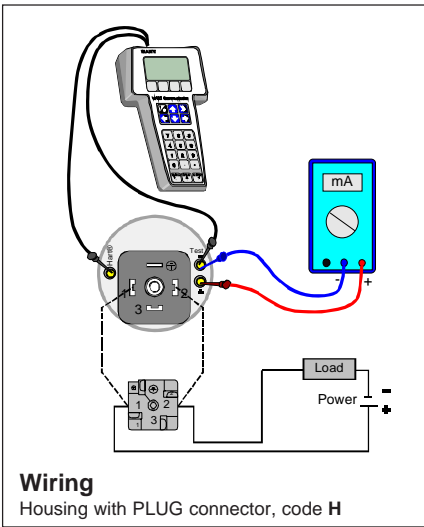



Housing with display, code N

Keyboard :

- Esc = Press **Esc** move back towards the top of the main menu.
- ▲ = Use the **UP** arrow key to move up on the current menu level or to increase the selected parameter value.
- ▼ = Use the **DOWN** arrow key to move down on the current menu level or to decrease the selected parameter value.
- Enter = Press **ENTER** to move to a lower level in a menu or to accept a command or parameter value.

Selection Chart

Adjustability	Span, min.	Span, max.	Measuring range					
VVF _e 4	4kPa (40 mbar)	100 kPa (1000 mbar)	-100...+100 kPa (-1000...1000 mbar)					
VVF _e 5	10 kPa (100 mbar)	500 kPa (5000 mbar)	-100...+500 kPa (-1000...5000 mbar)					
Output		S 4-20mA DC/HART® -protocol						
Flange or thread sleeve	0	no flange or thread	DB	DN50 PN40	DC	DN80 PN40	AC	ANSI 2" 150lbs
	AD	ANSI 2" 300 lbs	AE	ANSI 3" 150 lbs	AF	ANSI 3" 300lbs	GA	G1A, male
	GB	G1½A, male	GC	G2A, male	NA	1½ - NPT, male	NB	2 - NPT, male
Wetted materials	Flange or thread sleeve		Diaphragm		Extension			
	Code	Material	Code	Material	Material			
	2	AISI316L (EN 1.4404)	2	AISI316L (EN 1.4435)	AISI316/PUR			
Fill fluid		S	Silicone oil	G	Inert oil			
Housing type								
H	Housing with PLUG-connector, DIN43650, no display, inlet PG9							
M	Housing with junction box/terminal strip, no display, inlet M20x1,5							
N	Housing with junction box/terminal strip, with display, inlet M20x1,5							
Explosion proof		0	No explosion proof classification		1	Atex Intrinsic Safety,  II 2 GD T135°C		
Length P of PTFE/AISI316 hose between sensing element and housing								
P10 1.0 m hose								
P25 2.5 m hose								
...								
P500 50.0 m hose								
Length E of mounting/protective tube						E10	1.0 m hose	
						E15	1.5 m hose	
						...		
						E55	5.5 m hose	
								
Other mounting accessories		0	No separate fastening parts					
		1	Separate fastening part for cable, adjustable					
		2	Mounting bracket and protective tube					
Special size of electrical inlet								
N	1/2 NPT	G	Pg13.5	P	Plug DIN 43650			
Documentation								
Calibration Certificate			AE English					
Installation and Operating Instructions			IE English		IF Finnish			
Material Certificates								
0 No material certificate								
MC1 Raw materials certificate without appendices, in accordance with SFS-EN 10204-2.1 (DIN 50049-2.1) standard								
MC2 Raw materials certificate for wetted parts with appendices, in accordance with SFS-EN 10204-2.2 (DIN 50049-2.2) standard								
MC3 Raw materials certificate for wetted parts with appendices, in accordance with SFS-EN 10204-3.1B (DIN 50049-3.1B) standard								

We reserve the right for technical modifications without prior notice.
 HART® is a registered trademark of HART Communication Foundation.
 Hastelloy® is the registered trademark of Haynes International.
 Teflon® is the registered trademark of E.I. du Pont de Nemours & Co.
 Viton® is the registered trademark of DuPont Dow Elastomers.

